

TB - 75 - BI-FOLD
Bi-Folding Door System (Thermally Broken)
Typical Elevations

SS = Standard Shutter
LS = Large Shutter
HE = Hinge
FR = Full Roller Assembly
HR = Half Roller Assembly
M = Magnet

DOOR TYPE BR3A

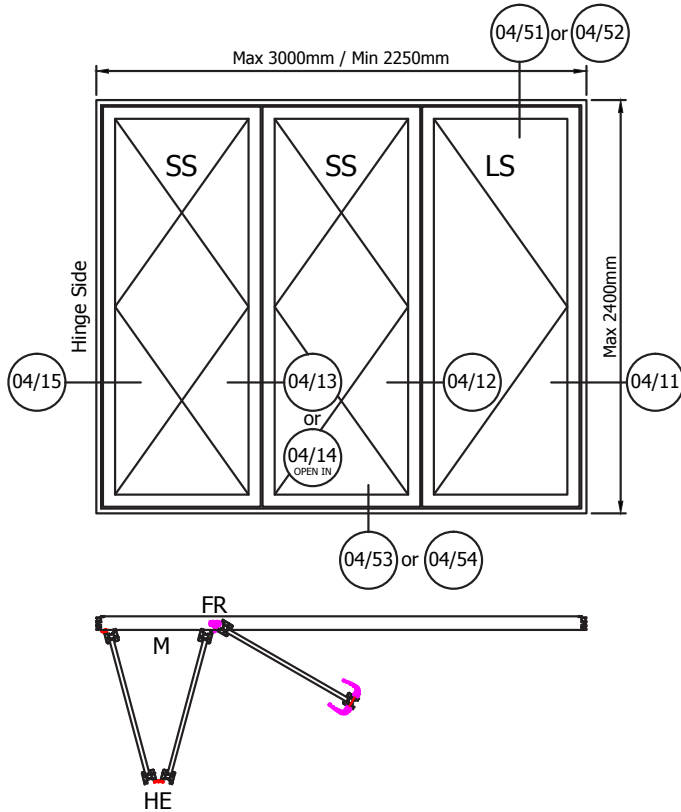

DOOR TYPE BR5A

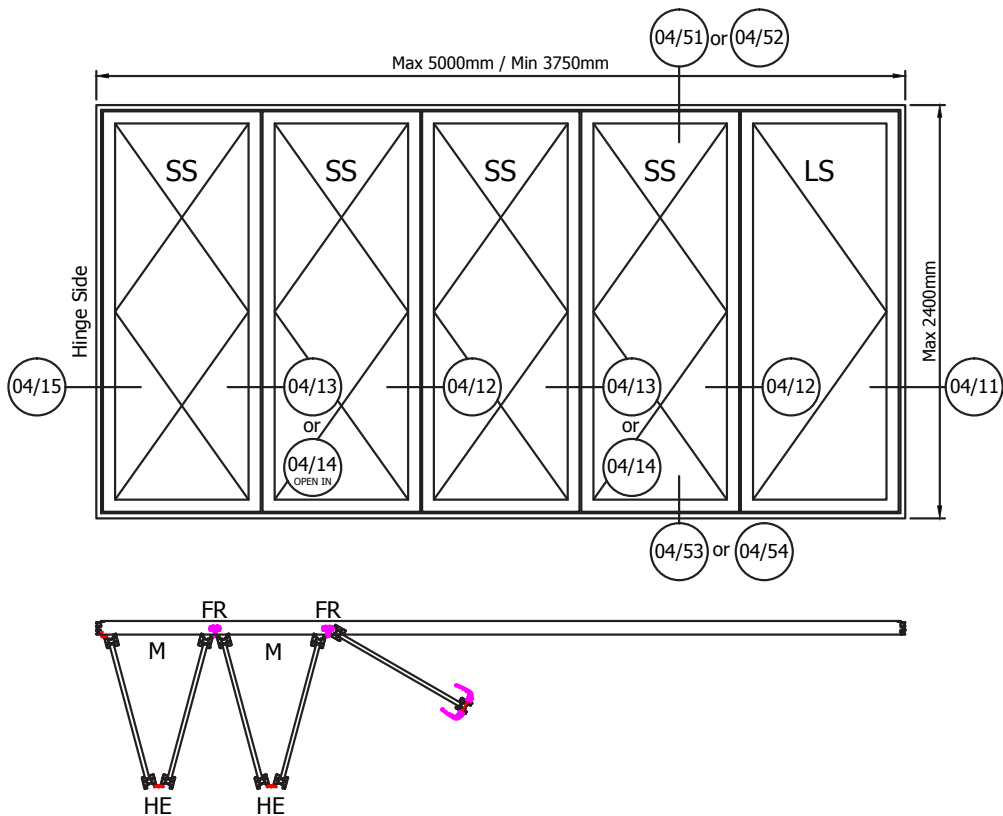

TB - 75 - BI-FOLD
Bi-Folding Door System (Thermally Broken)
Typical Elevations

SS = Standard Shutter
LS = Large Shutter
HE = Hinge
FR = Full Roller Assembly
HR = Half Roller Assembly
M = Magnet

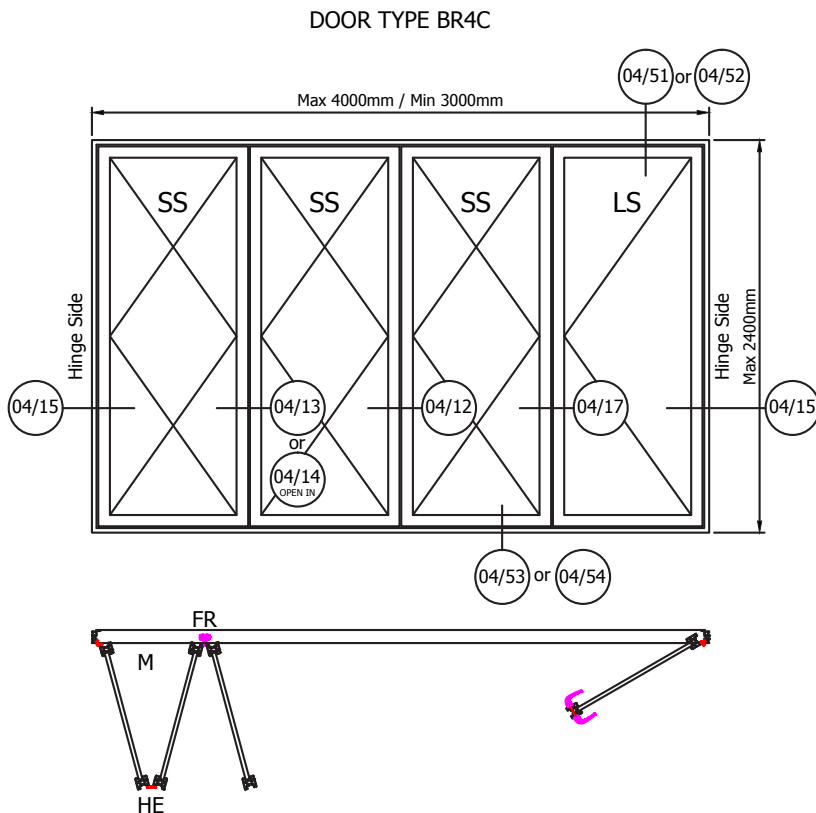
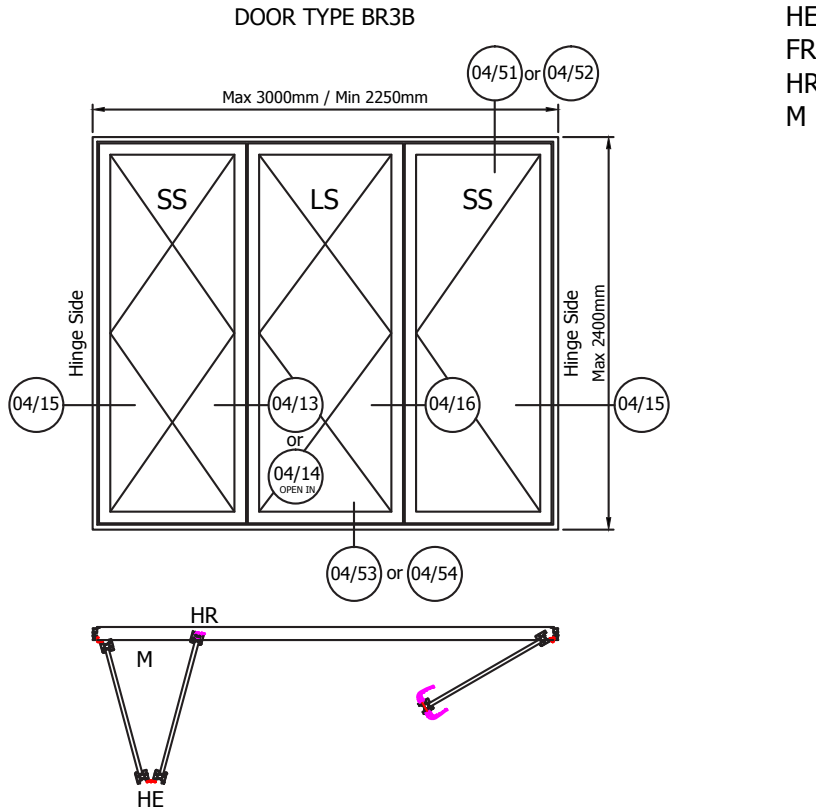

TB - 75 - BI-FOLD
Bi-Folding Door System (Thermally Broken)
Typical Full Size Sections

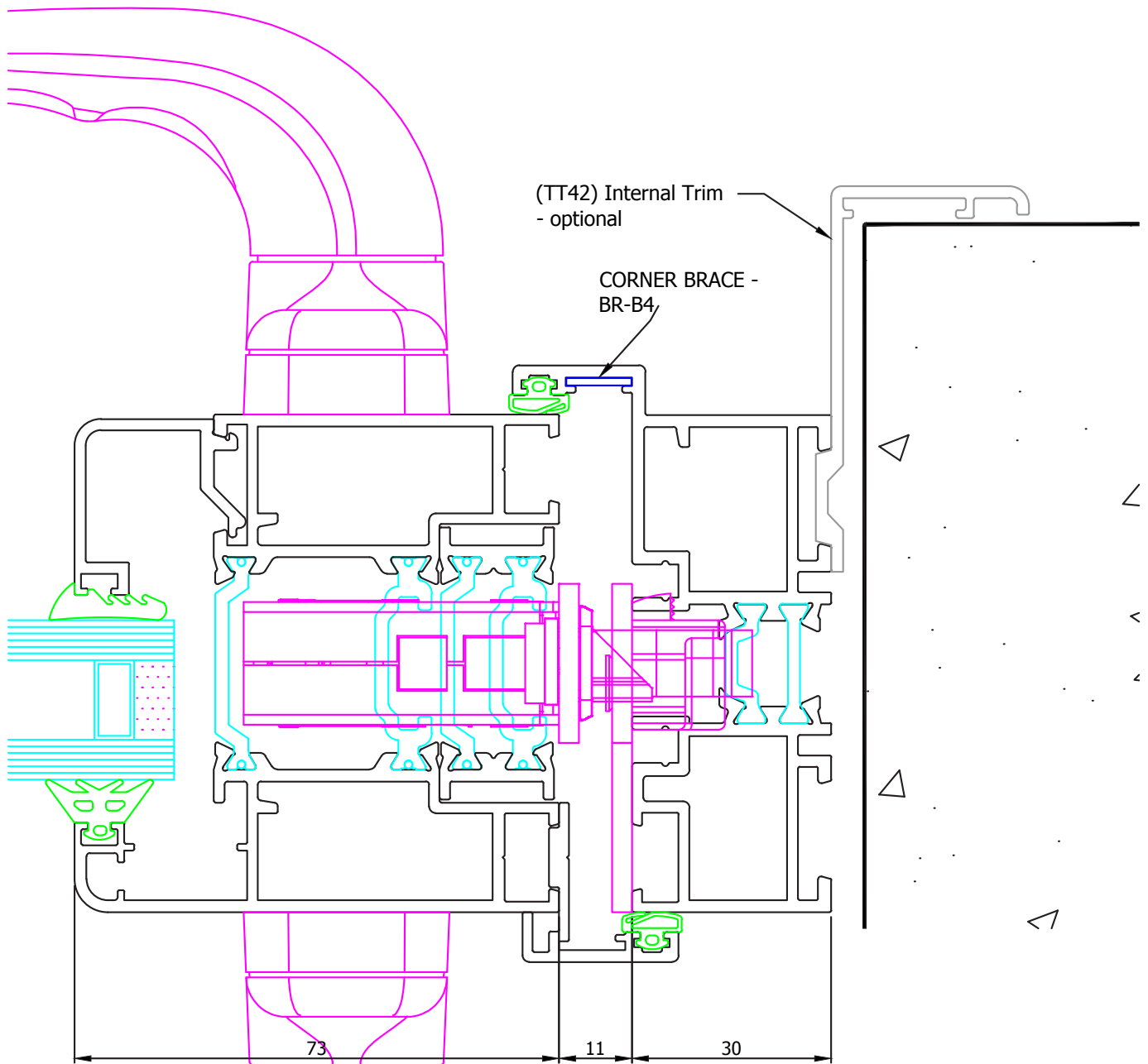

OUTER FRAME	BR-BF01-18-02
SHUTTER	BR-BF03-32-04
SHUTTER LINER	BR-BF05-32-05
WEATHER SEAL PROFILE	BR-BF11
WEATHER SEALS	BR-01
U _f VALUE (20°C internal - 0°C external)	3.55 (W/sqm-k)
U _f VALUE (20°C internal - 40°C external)	3.73 (W/sqm-k)
I _{xx} (cm ⁴)	N/A

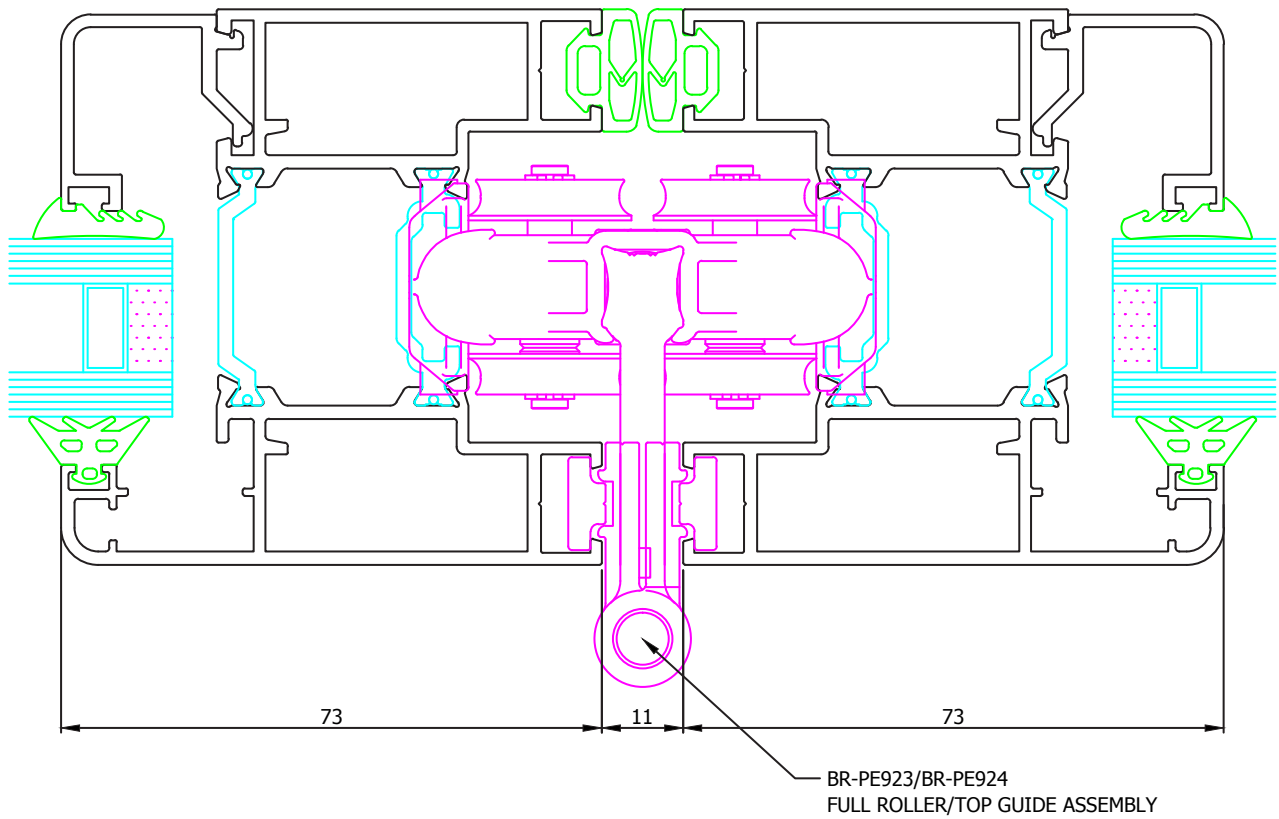

SHUTTER	BR-BF03-32-04
WEATHER SEALS	BR-70
U _f VALUE (20°C internal - 0°C external)	2.92 (W/sqm-k)
U _f VALUE (20°C internal - 40°C external)	3.14 (W/sqm-k)
I _{xx} (cm ⁴)	N/A

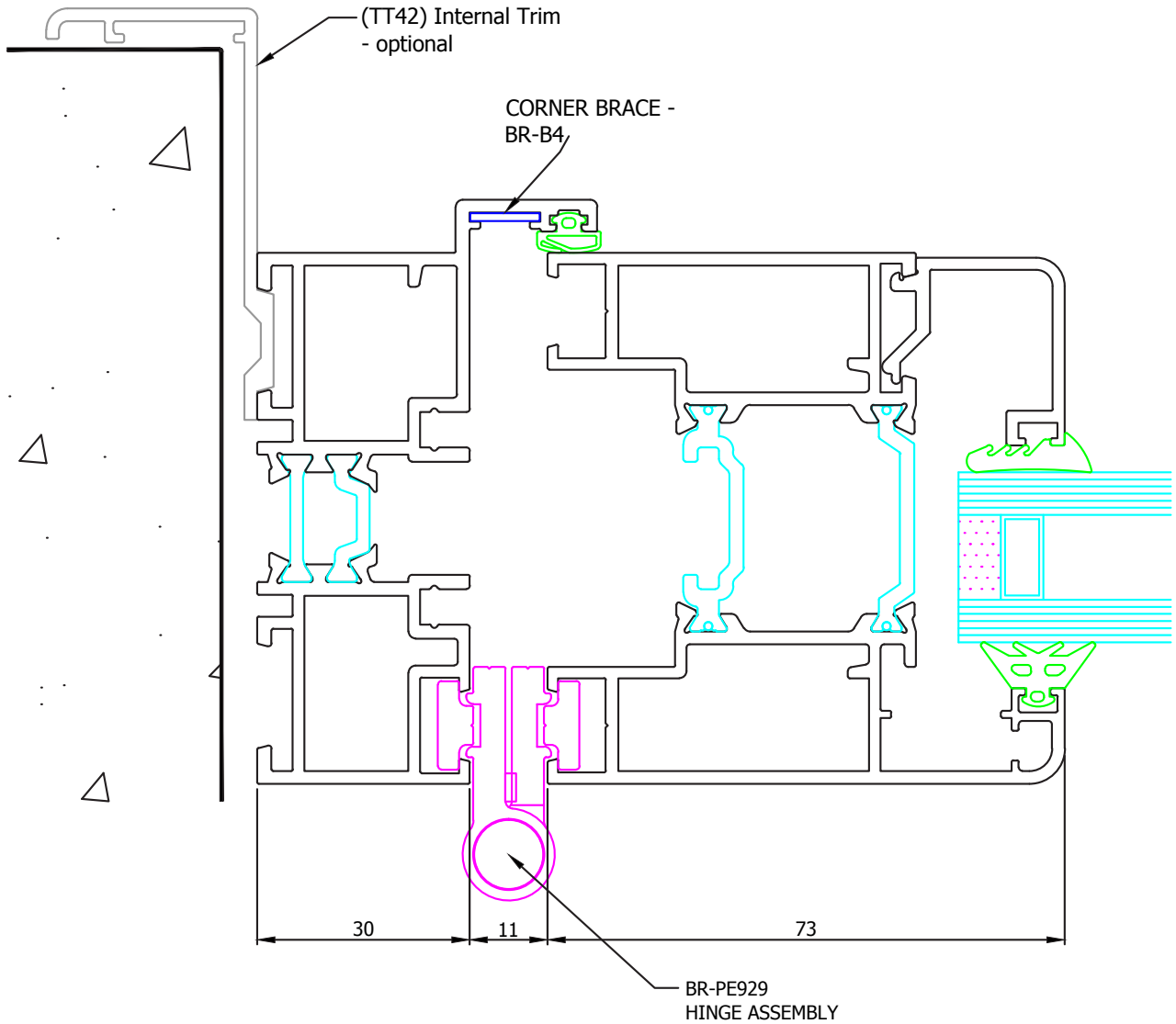

OUTER FRAME	BR-BF01-18-02
SHUTTER	BR-BF03-32-04
WEATHER SEALS	BR-01
U _f VALUE (20°C internal - 0°C external)	3.52 (W/sqm-k)
U _f VALUE (20°C internal - 40°C external)	3.72 (W/sqm-k)
I _{xx} (cm ⁴)	N/A

OPEN OUT

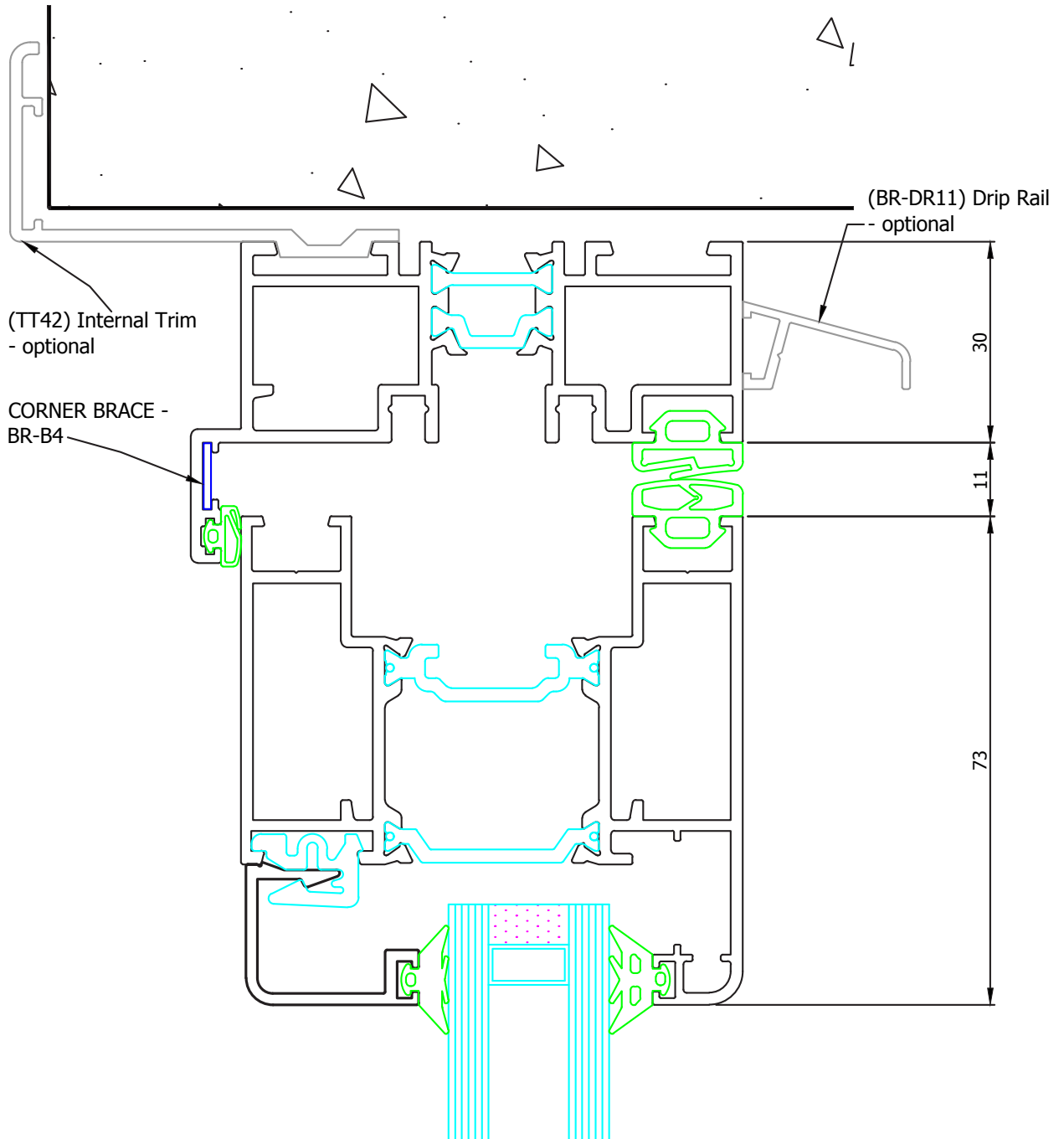

OUTER FRAME	BR-BF01-18-02
SHUTTER	BR-BF03-32-04
WEATHER SEALS	BR-01, BR-70 and BR-71
U _f VALUE (20°C internal - 0°C external)	3.52 (W/sqm-k)
U _f VALUE (20°C internal - 40°C external)	3.72 (W/sqm-k)
I _{xx} (cm ⁴)	N/A

LOW THRESHOLD

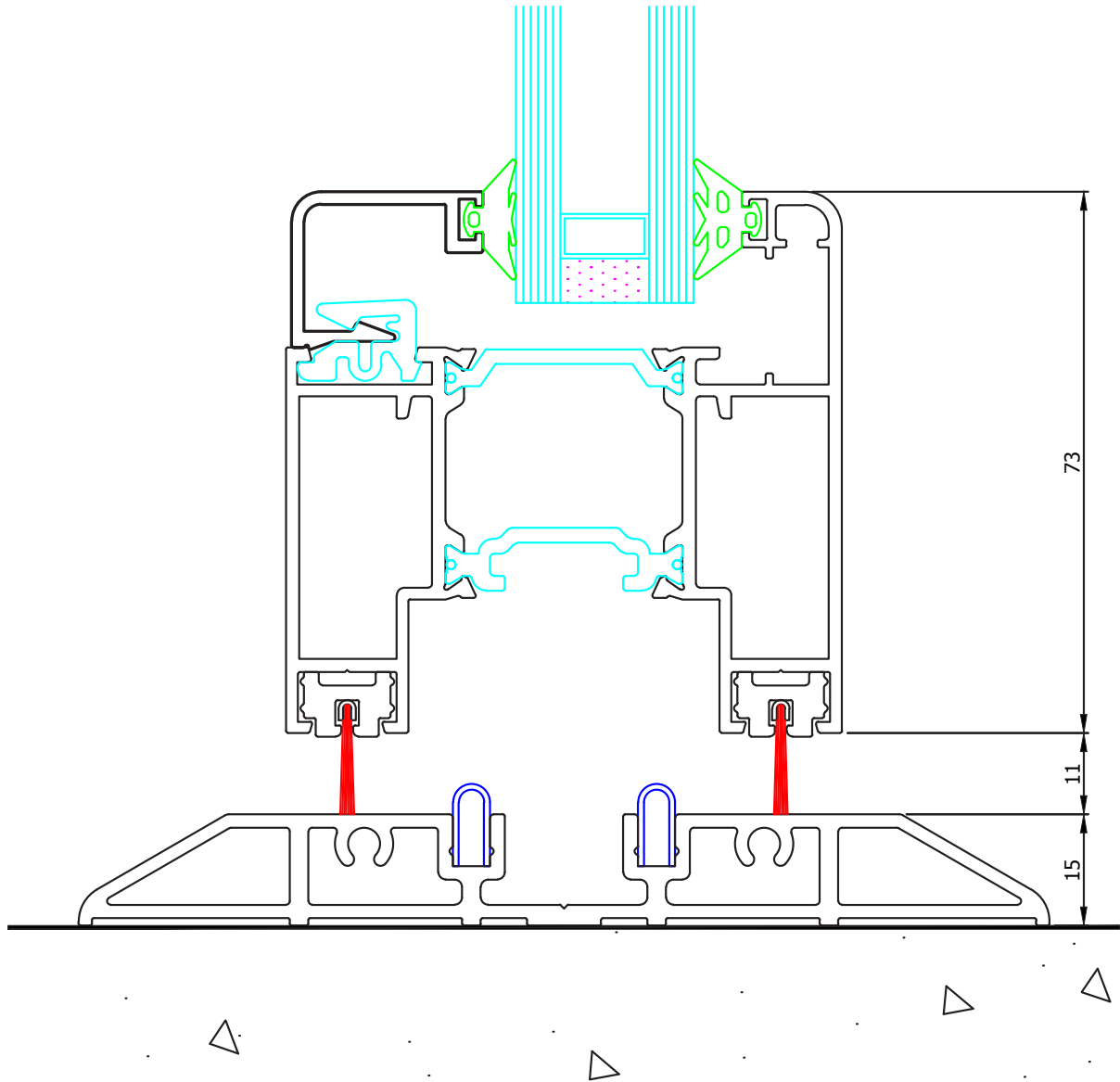

SHUTTER	BR-BF03-32-04
THRESHOLD	BR-BF06
ST/STEEL TRACK	BR-BF12
U _f VALUE (20°C internal - 0°C external)	4.71 (W/sqm-k)
U _f VALUE (20°C internal - 40°C external)	4.92 (W/sqm-k)
I _{xx} (cm ⁴)	N/A